

# CT16 Series Toaster

## Installation and Operation Manual

 **Frymaster**<sup>®</sup>



**CFESA**  
Commercial Food Equipment Service Association

Frymaster, a member of the Commercial Food Equipment Service Association, recommends using CFESA Certified Technicians.

**24-Hour Service Hotline 1-800-551-8633**

**819-5992  
OCTOBER 2003**

**NOTICE**

IF, DURING THE WARRANTY PERIOD, THE CUSTOMER USES A PART FOR THIS ENODIS EQUIPMENT OTHER THAN AN UNMODIFIED NEW OR RECYCLED PART PURCHASED DIRECTLY FROM FRYMASTER/DEAN, OR ANY OF ITS AUTHORIZED SERVICE CENTERS, AND/OR THE PART BEING USED IS MODIFIED FROM ITS ORIGINAL CONFIGURATION, THE WARRANTY WILL BE VOID. FURTHER, FRYMASTER/DEAN AND ITS AFFILIATES WILL NOT BE LIABLE FOR ANY CLAIMS, DAMAGES OR EXPENSES INCURRED BY THE CUSTOMER WHICH ARISE DIRECTLY OR INDIRECTLY, IN WHOLE OR IN PART, DUE TO THE INSTALLATION OF ANY MODIFIED PART AND/OR PART RECEIVED FROM AN UNAUTHORIZED SERVICE CENTER.

**NOTICE**

This appliance is intended for professional use only and is to be operated by qualified personnel only. A Frymaster/DEAN Factory Authorized Service Center (FASC) or other qualified professional should perform installation, maintenance, and repairs. Installation, maintenance, or repairs by unqualified personnel may void the manufacturer's warranty.

**NOTICE**

This equipment must be installed in accordance with the appropriate national and local codes of the country and/or region in which the appliance is installed.

**NOTICE TO U.S. CUSTOMERS**

This device complies with Part 15 of the FCC rules. Operation is subject to the following two conditions: 1) This device may not cause harmful interference, and 2) This device must accept any interference received, including interference that may cause undesired operation. While this device is a verified Class A device, it has been shown to meet the Class B limits.

**NOTICE TO CANADIAN CUSTOMERS**

This digital apparatus does not exceed the Class A or B limits for radio noise emissions as set out by the ICES-003 standard of the Canadian Department of Communications.

Cet appareil numérique n'émet pas de bruits radioélectriques dépassant les limites de classe A et B prescrites dans la norme NMB-003 édictée par le Ministre des Communications du Canada.

** DANGER**

Improper installation, adjustment, maintenance or service, and unauthorized alterations or modifications can cause property damage, injury, or death. Read the installation, operating, and service instructions thoroughly before installing, operating or servicing this equipment.

Do not operate the CT16 Toaster unless it has been properly installed and checked.

Do not operate the CT16 Toaster unless all covers and access panels are in place and properly secured.

Do not attempt to repair or replace any component of the CT16 Toaster unless all power to the unit has been disconnected.

Use caution when setting up, operating, or cleaning the CT16 Toaster to avoid contact with heated surfaces.

** DANGER**

Do not store or use gasoline or other flammable liquids or vapors in the vicinity of this or any other appliance.

**CT16 SERIES TOASTER  
INSTALLATION & OPERATION MANUAL  
TABLE OF CONTENTS**

---

1. Parts Ordering and Service Information.....	1
2. CT16 Toaster Operational Description .....	2
3. Installation/Setup.....	2
4. Operation.....	3
5. Viewing and Adjusting the Setpoint .....	3
6. Adjusting Bun Compression .....	4
7. Changing Belts .....	4
8. Operator Troubleshooting .....	5
9. Preventive Maintenance .....	6

# CT16 SERIES TOASTER INSTALLATION AND OPERATION MANUAL

---

## 1. Parts Ordering and Service Information

Parts orders may be placed directly with your local Frymaster Factory Authorized Service Center (FASC)/Distributor. A list of Frymaster FASCs was included with the unit when shipped from the factory. If you do not have access to this list, contact the Frymaster Service Department at 1-800-551-5633 or 1-318-865-1711.

To speed up your order, the following information is required:

Model Number \_\_\_\_\_  
Serial Number \_\_\_\_\_  
Voltage \_\_\_\_\_  
Part Number \_\_\_\_\_  
Quantity Needed \_\_\_\_\_

Service may be obtained by contacting your local FASC or Distributor. Service information may be obtained by calling the Frymaster Service Department. The following information will be needed in order to assist you quickly and efficiently.

Model Number \_\_\_\_\_  
Serial Number \_\_\_\_\_  
Nature of Problem \_\_\_\_\_  
\_\_\_\_\_  
\_\_\_\_\_  
\_\_\_\_\_

Also include any other information which may be helpful in solving your service problem.

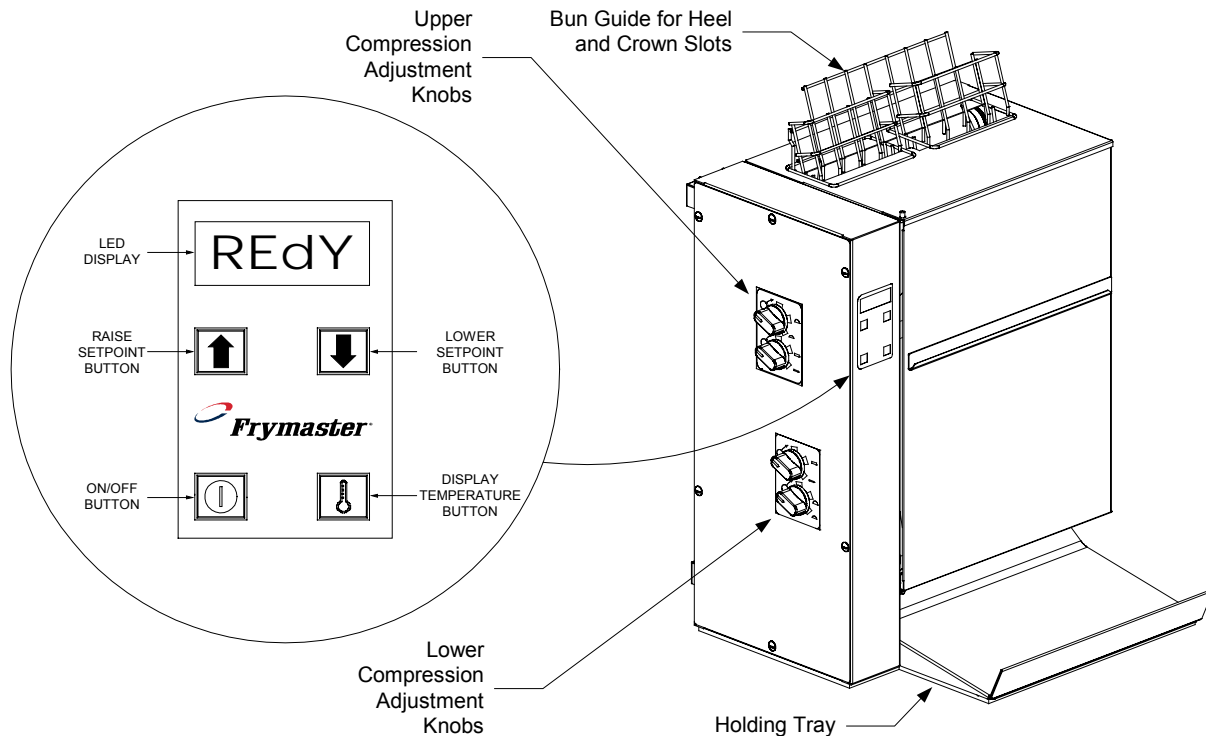

## 2. CT16 Toaster Operational Description

The CT16 Toaster is designed to produce fresh, uniformly toasted buns on an "as needed" basis. The countertop-mounted unit consists of a cabinet, a computer, a heating element and a pair of conveyor assemblies.

When the unit is turned on, an electrical heating element (called a *platen*) is energized. The platen heats up to a programmed temperature referred to as the *setpoint*. At the same time, both conveyor assemblies are activated. When a bun is placed into one of the slots at the top of the cabinet, the conveyor belts gently carry it through the unit, with the cut face of the bun passing over the heated platen. As the bun passes over the platen, it is toasted. At the end of the process, the bun is deposited onto a holding tray.

The computer allows the operator to adjust the setpoint to obtain desired toasting characteristics. Compression adjustment knobs also allow the operator to adjust the compression of heels and crowns as they pass through the toaster.

## 3. Installation/Setup

Upon arrival, inspect the toaster for concealed damage. Immediately report any damage to the delivering freight company. Claims must be filed within 15 days after receipt of the unit.

### **Power Requirements:**

**ALL ELECTRICALLY OPERATED APPLIANCES MUST BE ELECTRICALLY GROUNDED IN ACCORDANCE WITH LOCAL CODES, OR IN THE ABSENCE OF LOCAL CODES, WITH THE NATIONAL ELECTRICAL CODE (ANSI/NFPA NO. 70-1990) OR THE CORRESPONDING NATIONAL CODE OF THE COUNTRY IN WHICH INSTALLED.**

**THIS APPLIANCE IS EQUIPPED WITH A GROUNDING PLUG FOR YOUR PROTECTION AGAINST SHOCK HAZARD AND MUST BE PLUGGED INTO A PROPERLY GROUNDED RECEPTACLE. DO NOT CUT OR REMOVE THE GROUNDING PRONG FROM THIS PLUG!**

- Voltage: 208VAC or 240VAC depending on model ordered
- Frequency: 60 Hz (non-CE) or 50 Hz (CE and Australian models)

- Phase: Single
- Service: 30 Amp

**Setup:**



Setup of the toaster consists of unpacking the unit, placing it on a sturdy table or countertop adjacent to a properly grounded AC outlet of appropriate voltage, removing the cardboard packing inserts, installing the bun feeder in the slot on top of the cover, and plugging it in. **NOTE:** The cover must be closed to install the bun feeder, and the bun feeder must be removed to open the cover.

The unit is shipped with a programmed setpoint of 550°F (288°C), upper crown compression knob set to **4**, lower crown compression knob set to **5**, upper heel compression knob set to **D**, and lower heel compression knob set to **E**. The operator may change these settings to attain desired toasting.

**4. Operation**

1. Press the ON/OFF  button. The word LOW will appear in the green LED display window. The unit will take about 10 minutes to reach operating temperature, at which time the display will change to REDY, indicating the toaster is ready for use.
2. Load buns into the appropriate slots (Heel or Crown) one at a time, with the cut faces toward the rear of the unit. The unit will toast the buns and transfer them to the holding tray.
3. Adjust the setpoint and bun compression as necessary to achieve desired toasting.





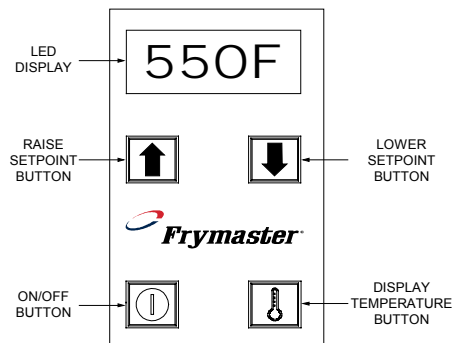



**5. Viewing and Adjusting The Setpoint**

**To view the platen temperature:** Press the  button once. The temperature in degrees Fahrenheit will appear in the green LED display window. To view the current setpoint, press the  button twice. The setpoint in degrees Fahrenheit will be displayed in the green LED display window.



**To change the display from Fahrenheit to Celsius:** Unplug the unit, then press and hold the  button as the unit is plugged back in.

**To change the setpoint:**

1. Turn the unit OFF (press the  button). Enter the setpoint programming mode by pressing the , , ,  buttons in that order. The current setpoint will appear in the LED display. To increase the setpoint, press the  button; to decrease it, press the  button.
2. When the desired setpoint is displayed, press the  button once. Press the ON/OFF  button. If the platen is within 20°F (11°C) of the setpoint, the display will show REDY. Otherwise, the display will show LOW or HIGH until the platen is within 20°F (11°C) of the setpoint, at which time the display will change to REDY.

## 6. Adjusting Bun Compression

1. There are two pairs of compression adjustment knobs (one pair numbered 1-5, the other lettered A-E), as shown in the accompanying illustration. Factory settings are circled.

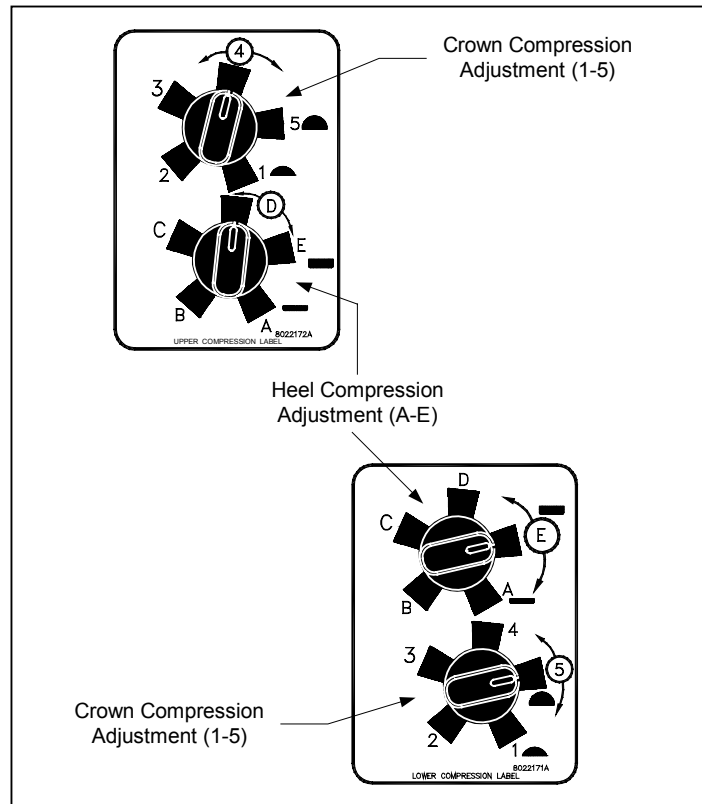

2. Settings A and 1 cause the greatest bun compression (that is, the thinnest bun after toasting).

## 7. Changing Belts

1. Turn the unit off (press the ON/OFF  button) then unplug it. If the unit has been in operation, allow it to cool for about 1½ hours. **TIP:** Change belts in the morning, prior to turning the toaster on.
2. **Remove the bun feeder**, and then open the cover.
3. Set the bun compression knobs to positions **E** and **5**.
4. Press down on the top roller and move it to the retracted (down) position. (**NOTE:** Each side of the roller must be locked down.)

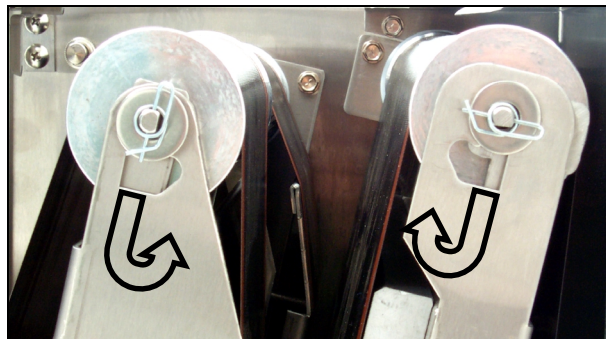

5. Rotate the tray stabilizer latch upward to unlatch it.

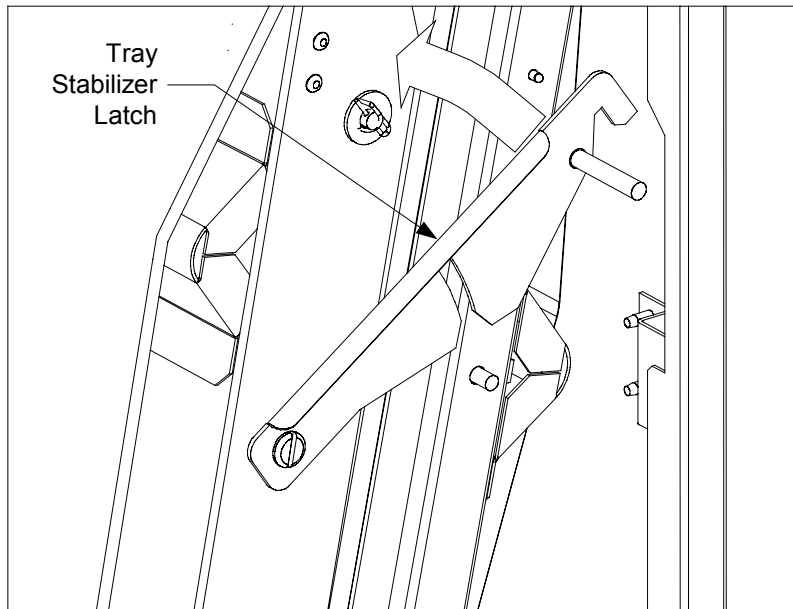

6. Slip the old belt off the rollers and slip the new belt on. When the replacement belt has been properly positioned between the raised edges of its rollers, rotate the tray stabilizer latch to the latched position.

7. Press down on the top roller to unlock it and allow it to extend.

8. Close the cover. Return the bun compression knobs to their previous settings.

## 8. Operator Troubleshooting

PROBLEM	PROBABLE CAUSES	CORRECTIVE ACTION
PRO1 in LED display.	A. Indicates failure of main platen probe or associated circuitry.	A. Call FASC.
PRO2 in LED display.	B. Indicates failure of holding tray resistor.	B. Call FASC.
Bun conveyors do not start when ON/OFF button is pressed.	A. Cover not properly installed.	A. Make sure cover is correctly positioned so that the cover interlock switch is depressed.
	B. Toaster not plugged in.	B. Plug toaster in.
	C. Store circuit breaker tripped.	C. Reset circuit breaker.
	D. Failed cover interlock switch, failed high limit, failed motor, or failed controller.	D. Call FASC.
Toasting is consistently too dark or too light.	A. Improper setpoint programmed and/or incorrect compression knob setting.	A. If toasting is too dark, lower the setpoint and/or compression setting until desired toasting is achieved.  If toasting is too light, increase setpoint and/or compression setting until desired toasting is achieved.



PROBLEM	PROBABLE CAUSES	CORRECTIVE ACTION
Buns are too thick or too thin.	A. Compression knobs on an improper setting for desired compression.	A. Adjust the compression knobs to achieve desired compression. Moving them to a lower setting will increase compression. Moving them to a higher setting will decrease compression. Make sure both pairs of knobs are on the same setting.
Buns are toasting inconsistently.	A. Belt slippage.	A. Shut down and clean unit, paying particular attention to grooves in rollers and condition of belts.
	B. Incorrect belt speed, faulty platen heater, or faulty controller.	B. Call FASC.

## 9. Preventive Maintenance

The toaster should be cleaned on a daily basis. Remove the cover. Remove the belts, wash them in solution of detergent and warm water, and dry them thoroughly. Use a basting brush or similar soft-bristled brush to whisk crumbs from the unit. Alternatively, a small vacuum may be used to remove crumbs from the unit. Wipe down all metal surfaces with cloth dampened with a solution of detergent and warm water, the wipe again with a cloth dampened with clean warm water. If necessary, use a stiff-bristled brush to dislodge stubborn residue from the grooves in the rollers, then wipe them down.

Additionally, Frymaster recommends that a Frymaster Factory Authorized Service Technician inspect this appliance at least annually as follows:

- Inspect all wiring for signs of chafing, kinking, and/or loose connections.
- Verify that all mechanical and electronic components are securely mounted (i.e., screws and nuts and bolts are tight.)
- Verify that idler roller springs are in serviceable condition (i.e., rollers are held securely in the top of the J-slots and belts do not slip).



**Frymaster, L.L.C., 8700 Line Avenue, PO Box 51000, Shreveport, Louisiana 71135-1000**  
**Shipping Address: 8700 Line Avenue, Shreveport, Louisiana 71106**

**TEL 1-318-865-1711 FAX (Parts) 1-318-219-7140 FAX (Tech Support) 1-318-219-7135**

**PRINTED IN THE UNITED STATES**

**SERVICE HOTLINE**  
**1-800-551-8633**

**Price: \$6.00**  
**819-5992**  
**OCTOBER 2003**